

BÖLLHOFF

Self-Tapping Fasteners

Efficient fastening technology for solid metal, sheet metal and plastics

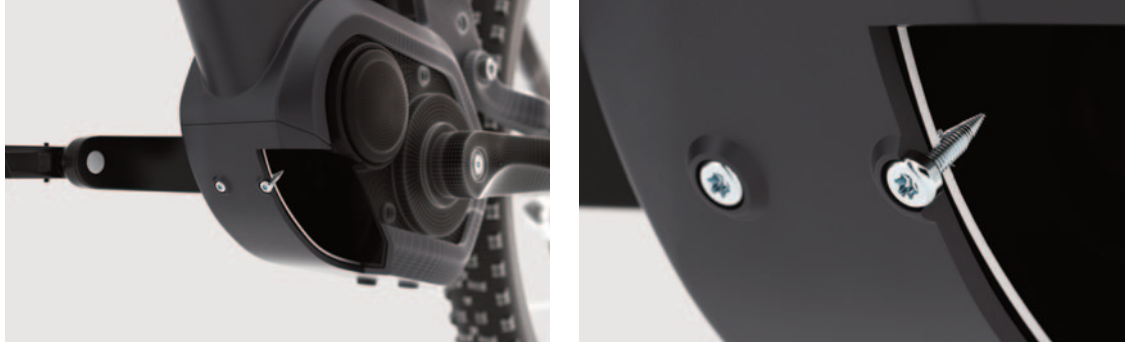



In every industry, lightweight construction has become central in the manufacture of goods. For instance, companies in the mobility sector have no choice but to develop lighter, more efficient designs, regardless of whether they rely on innovative drive systems or conventional technology. And these industries are not the only ones. Self-tapping fasteners play a crucial role to make this possible. In addition to possible weight reduction, they have further advantages such as less material use, the reduction of component wall thicknesses, and faster production cycles.

As the share of lightweight high-tech materials increases, fastening technology requires continuous innovation to reduce the overall weight of the components while creating long-lasting, secure joints between these components. Self-tapping fasteners play a significant role in this: thread-forming screws form their own thread when screwed into pilot holes, or, depending on the type of screw, can also generate pilot holes themselves. This eliminates the need to create additional mating threads or use nut elements and thread inserts, which are unavoidable with conventional metric threads. In addition, the use of self-tapping fasteners increases productivity in the assembly process, reduces component weights, and ultimately reduces production costs.

Another advantage of self-tapping fasteners: the screw forms the mating thread in the material. Thread grooving deflects the course of the fibers in the material. This process causes partial hardening of the material, which ensures a higher load capacity of the female thread. For the self-tapping fastening process, it is important for the screw threads to have a higher strength than the components into which they are screwed in and for the material of the components to be sufficiently ductile.

Technological differences between conventional methods and self-tapping fasteners

Cut metric threads

Disadvantages

- Cuts through the fibers
- Backlash due to tolerances
- Additional processes
- Thread cutting produces chips

Grooved metric thread

Advantages

- Work hardening makes internal threads more robust in case of self-tapping fastening in metal
- No chip formation/contamination of the assembly
- Chip-free threads increase the locking effect
- Grooved threads are compatible with metric threads

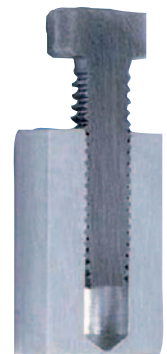
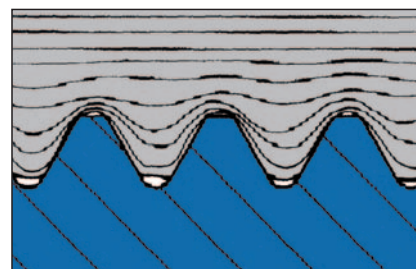
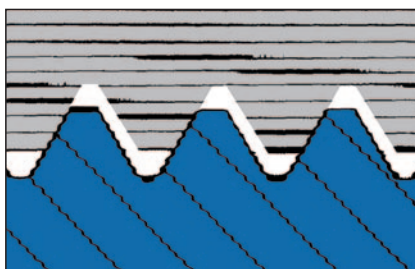

Tighten the screws on costs

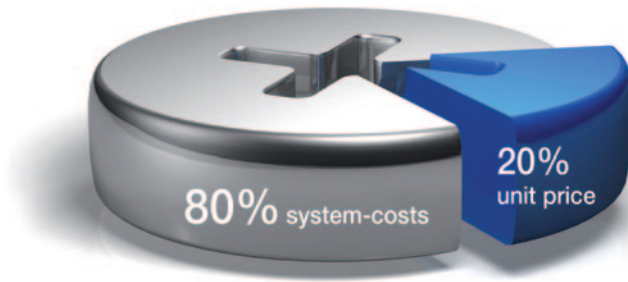

Self-tapping fasteners offer advantages at various levels and can make a significant contribution to reduce production costs. Within the total costs of a screw connection, 80% of the costs on average are system costs, while only 20% are affected by the costs of the parts. As a result, self-tapping fasteners can significantly reduce manufacturing costs.

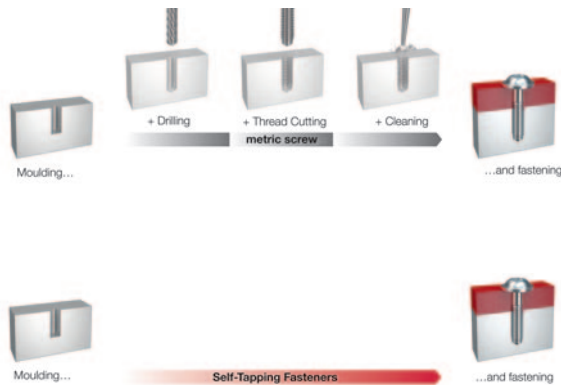

Examples of process-related advantages of self-tapping fasteners:

- Fewer work steps during assembly
- Consistent reduction of production costs
- Elimination of sources of error
- Potential for standardization and reduction of tool costs

Design notes

To ensure reliable connections with self-tapping fasteners, it is necessary to take certain design parameters into account and, if applicable, to include them in the design of the component geometry.

Relief bores for plastics

The relief bore is an important feature in self-tapping plastic screw connections, ensuring that the material has sufficient space to flow into the transition to the fastening material when screwed in. This guarantees even head contact and reduces the radial stress at the edge of the bore.

Pilot hole diameter

To be able to transmit force in the component while also controlling the assembly parameters, the choice of the pilot hole diameter is crucial. However, the right diameter can differ significantly depending on the material used, the assembly process, the required clamping force, and the tube diameter.

Additional hole depth

Additional hole depth serves to ensure the threaded tip does not make contact until the screw head makes contact, so that the preload force can build up. This design specification also allows a kind of reservoir for chipping screw connections or screw connections that generate dust. The material can accumulate in the reservoir without disturbing the screwing process.

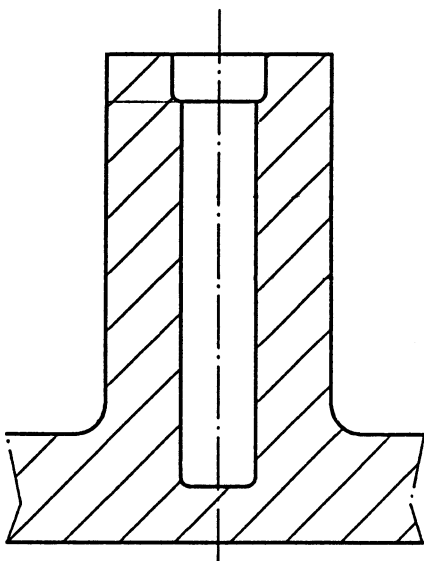

Using self-tapping fasteners for assembly requires more precise consideration of the assembly parameters than conventional screw connections. Some of the torque that is applied is used to form the thread. This torque is called the insertion torque (M_e). The maximum torque, also called the overtorque ($M_{\bar{v}}$), represents the upper limit for the joint.

If this limit is exceeded, the joint is destroyed. Therefore, an installation torque or cut-off torque between the insertion torque and overtorque should be selected and must be determined by tests or calculations. A large delta between the insertion torque and overtorque is advantageous for reliable screwed joints. For example, this can help to compensate for variation in the assembly process due to tolerances.

Furthermore, a distinction is made between two types of screwed joints:

Through-hole screw connections are characterized by the fact that two pre-punched components are screwed together. The clamping part (the upper part) is provided with a larger hole. A pilot hole of a specified diameter, which depends on the production process (e.g., punching, drilling, etc.), is provided at the lower part, the screw-in part. The following three assembly phases after the pre-punching can be defined:

1) Thread forming

In this phase, the mating thread is grooved into the base material. This causes high friction, which is reflected in a continuous increase in torque.

2) Screw-in

In this stage of the process, there is no torque increase, since all the threads have already been cut. Therefore, the torque curve enters a level valley. However, the torque does not go down to 0 Nm, since a minimum torque is required to overcome the thread friction during the screw-in process.

3) Tightening

When the screw head makes contact, the torque increases abruptly, and the curve rises exponentially. The interaction of head friction and thread friction is cumulative and requires the screwing device to be switched off before the thread is destroyed.

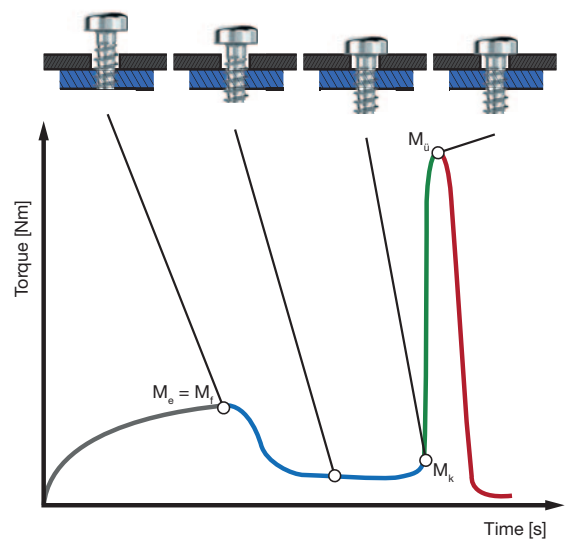

Through-hole screw connection parameters:

M_e = insertion torque
Torque while female thread is being grooved

M_k = torque when head makes contact

M_A = tightening torque
Value between M_e and $M_{\bar{v}}$ for direct screw connections

$M_{\bar{v}}$ = overtorque
Torque at which the thread that was formed previously is destroyed

For **blind-hole screw connections**, the screw-in depth is limited by the geometry. Therefore, the selection of the screw length is crucial. If the screw selected is too short, the screw may not be able to absorb sufficient operating force. If the screw is too long, it will not be possible to screw it up to the point of head contact. Blind-holes also show three characteristic phases, but the details differ:

1) Thread forming

As with through-hole screw connections, the torque increases due to the deflection of the fibers in the material as the threads are created.

2) Screw-in

The screw-in process is the most significant difference with blind holes: the torque increases continuously, because the thread grooving process progresses until the head makes contact.

3) Tightening

When the head makes contact, the torque increases rapidly. Determining an optimum cut-off torque can be more challenging with this type of screw connection, since the torque that occurs when the head makes contact is higher, and thus it is closer to the destructive overtorque.

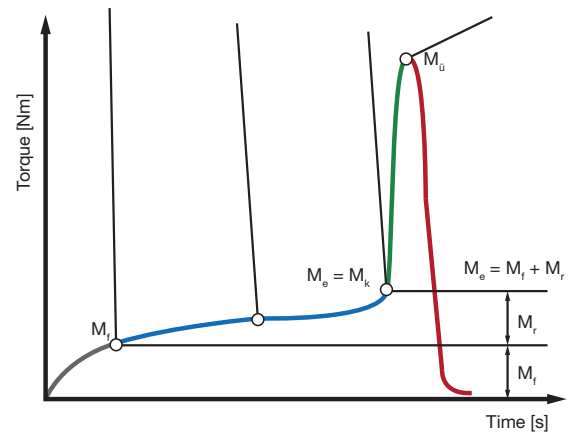
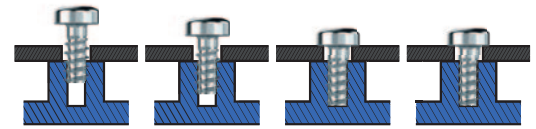

Blind-hole screw connection parameters:

M_t = thread forming torque

M_r = frictional torque in the thread

M_k = head contact torque

M_e = insertion torque
Torque while female thread is being grooved

M_u = overtorque
Torque at which the thread that was formed previously is destroyed



Self-tapping fasteners for plastics

Page

EJOT PT® – The original plastic screw connection

7

EJOT DELTA PT® – For challenging applications and materials

13

AMTEC® screw – Efficient and reliable

17

Self-taping fasteners for sheet metal

QUICK FLOW® – Reliable thin sheet metal screw connections

25

Self-tapping fasteners for solid metal

B7500 – The economical standard for a large number of applications

27

EJOT ALtracs® Plus – The universal solution for light metals

36

Self-tapping fasteners for plastics

EJOT PT®

The EJOT PT® is the first screw specially developed for thread forming in thermoplastics. For decades, it has set the standard for reliable self-tapping fasteners for thermoplastics. Possible uses for this fastener are found in all industrial applications and sectors. The proven PT® screw technology allows designers to create very flat, thin-walled designs. This makes it possible to save material and significantly shortens injection cycles in the production process, while it also reduces component weights.

Advantages of the EJOT PT® screws:

Radial forces

- Low radial forces for low radial expansion
- Large axial components for optimal material flow in the core groove

Displacement volumes

- Greater load-bearing depth of the thread for greater load capacity
- Lower insertion torques – since the lever arms are smaller for the same displacement volumes

Thread details

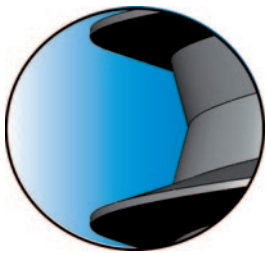

PT®-Thread

- 30° flank angle
- Large thread load and high load capacity
- Low insertion torques, since the lever arms are smaller for the same displacement volume
- Validated pitch
- Strong self-locking effect
- Balanced load ratio between the two materials

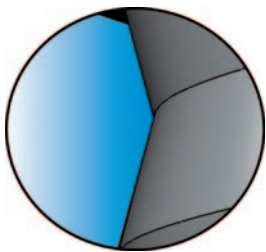

Core groove

- Optimal material flow during thread forming process
- Low radial expansion
- No material blockage in the core area
- No material damage
- Greater load capacity and greatest possible protection against relaxation when tube is optimal designed

Notes for designers

When designing and developing new components, certain parameters should be taken into account for the design. As a general rule, the design recommendations in the following table can be used as a guide. However, if deviations from the recommendations are to be expected due to differences in wall thicknesses, cavities, sink marks, etc., the tube cross-section must be adapted to the specific circumstances.

Improper increase in the tangential tension generated in the tube during assembly must be avoided, so the process should proceed in the appropriate sequence:

- Reduce tube diameter
- Increase screw diameter
- Therefore reduction in axial load capacity
- Increase of the screw-in depth
- To compensate for the reduced load capacity

In this case, a component inspection is recommended. We will be happy to help with our **in-house screw connection laboratory**.

The relief hole is particularly important, since it ensures a favorable distribution of edge stress.

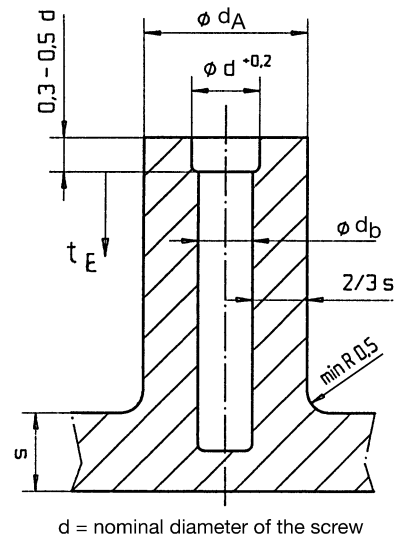

Design recommendations for EJOT PT® screws

Material	Hole diameter d_b	Outer diameter d_A	Screw-in depth t_s
ABS	0.80 x d	2.00 x d	2.00 x d
ABS PC Blend	0.80 x d	2.00 x d	2.00 x d
ASA	0.78 x d	2.00 x d	2.00 x d
PA 4.6	0.73 x d	1.85 x d	1.80 x d
PA 6	0.75 x d	1.85 x d	1.70 x d
PA 6.6	0.75 x d	1.85 x d	1.70 x d
PBT	0.75 x d	1.85 x d	1.70 x d
PE - LD	0.70 x d	2.00 x d	2.00 x d
PE - HD	0.75 x d	1.80 x d	1.80 x d
PET	0.75 x d	1.85 x d	1.70 x d
PET - GF 30	0.80 x d	1.80 x d	1.70 x d
POM	0.75 x d	1.95 x d	2.00 x d
POM - GF 30	0.80 x d	1.95 x d	2.00 x d
PP	0.70 x d	2.00 x d	2.00 x d
PP - GF 30	0.72 x d	2.00 x d	2.00 x d
PP -TV 20	0.72 x d	2.00 x d	2.00 x d
PS	0.80 x d	2.00 x d	2.00 x d
PVC (hart)	0.80 x d	2.00 x d	2.00 x d
SAN	0.77 x d	2.00 x d	1.90 x d

Standard product range



E 1411
EJOT PT® with button head and pressed-on washer,
cross slot (Phillips), zinc-plated

Diameter (mm) \ Length (mm)	2.2	2.5	3.0	3.5	4.0	5.0
6	E1411KA/VZ226	E1411KA/VZ256	E1411KA/VZ306			
8	E1411KA/VZ228	E1411KA/VZ258	E1411KA/VZ308	E1411KA/VZ358	E1411KA/VZ408	
10	E1411KA/VZ2210	E1411KA/VZ2510	E1411KA/VZ3010	E1411KA/VZ3510	E1411KA/VZ4010	E1411KA/VZ5010
12	E1411KA/VZ2212	E1411KA/VZ2512	E1411KA/VZ3012	E1411KA/VZ3512	E1411KA/VZ4012	E1411KA/VZ5012
14	E1411KA/VZ2214	E1411KA/VZ2514	E1411KA/VZ3014	E1411KA/VZ3514	E1411KA/VZ4014	E1411KA/VZ5014
16		E1411KA/VZ2516	E1411KA/VZ3016	E1411KA/VZ3516	E1411KA/VZ4016	E1411KA/VZ5016
18			E1411KA/VZ3018	E1411KA/VZ3518	E1411KA/VZ4018	E1411KA/VZ5018
20			E1411KA/VZ3020	E1411KA/VZ3520	E1411KA/VZ4020	E1411KA/VZ5020
22				E1411KA/VZ3522	E1411KA/VZ4022	E1411KA/VZ5022
25				E1411KA/VZ3525	E1411KA/VZ4025	E1411KA/VZ5025
30					E1411KA/VZ4030	E1411KA/VZ5030
35					E1411KA/VZ4035	E1411KA/VZ5035

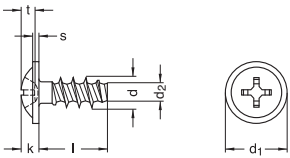

Diameter (d)	d ₁ Nominal dimension	d ₂ Nominal dimension	k Nominal dimension	s		Pitch (P)	t		Tool size
				min.	max.		min.	max.	
2.2	4.4	1.25	1.6	0.5	0.7	0.98	0.68	1.14	H 1
2.5	5	1.40	1.8	0.6	0.8	1.12	0.82	1.28	H 1
3	6	1.66	2.1	0.7	0.9	1.34	1.15	1.61	H 1
3.5	7	1.91	2.4	0.8	1.0	1.57	1.07	1.70	H 2
4	8	2.17	2.5	0.9	1.1	1.79	1.33	1.96	H 2
5	10	2.68	3.2	1.1	1.3	2.24	1.98	2.61	H 2

Nominal dimension	Length (l)		Nominal dimension	Length (l)	
	min.	max.		min.	max.
6	5.62	6.38	18	17.45	18.55
8	7.55	8.45	20	19.35	20.65
10	9.55	10.45	25	24.35	25.65
12	11.45	12.55	30	29.35	30.65
14	13.45	14.55	35	34.20	35.80
16	15.45	16.55			

Standard product range



E 1412
EJOT PT® with button head
cross-slot (Phillips), zinc-plated

Diameter (mm) \ Length (mm)	1.8	2.2	2.5	3.0	3.5	4.0	5.0
5	E1412KA/VZ185	E1412KA/VZ225	E1412KA/VZ255				
6	E1412KA/VZ186	E1412KA/VZ226	E1412KA/VZ256	E1412KA/VZ306			
8	E1412KA/VZ188	E1412KA/VZ228	E1412KA/VZ258	E1412KA/VZ308	E1412KA/VZ358	E1412KA/VZ408	
10	E1412KA/VZ1810	E1412KA/VZ2210	E1412KA/VZ2510	E1412KA/VZ3010	E1412KA/VZ3510	E1412KA/VZ4010	E1412KA/VZ5010
12		E1412KA/VZ2212	E1412KA/VZ2512	E1412KA/VZ3012	E1412KA/VZ3512	E1412KA/VZ4012	E1412KA/VZ5012
14		E1412KA/VZ2214	E1412KA/VZ2514	E1412KA/VZ3014	E1412KA/VZ3514	E1412KA/VZ4014	E1412KA/VZ5014
16		E1412KA/VZ2216	E1412KA/VZ2516	E1412KA/VZ3016	E1412KA/VZ3516	E1412KA/VZ4016	E1412KA/VZ5016
18			E1412KA/VZ2518	E1412KA/VZ3018	E1412KA/VZ3518	E1412KA/VZ4018	E1412KA/VZ5018
20			E1412KA/VZ2520	E1412KA/VZ3020	E1412KA/VZ3520	E1412KA/VZ4020	E1412KA/VZ5020
22				E1412KA/VZ3022	E1412KA/VZ3522	E1412KA/VZ4022	E1412KA/VZ5022
25				E1412KA/VZ3025	E1412KA/VZ3525	E1412KA/VZ4025	E1412KA/VZ5025
30				E1412KA/VZ3030	E1412KA/VZ3530	E1412KA/VZ4030	E1412KA/VZ5030
35							E1412KA/VZ5035
40							E1412KA/VZ5040

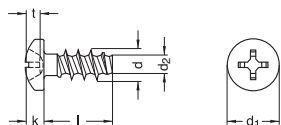

Diameter (d)	d ₁ Nominal dimension	d ₂ Nominal dimension	k Nominal dimension	Pitch (P)	t		Tool size
					min.	max.	
1.8	3.2	1.04	1.2	0.8	0.70	1.00	H 1
2.2	3.9	1.25	1.5	0.98	0.74	1.20	H 1
2.5	4.4	1.4	1.7	1.12	0.92	1.38	H 1
3	5.3	1.66	2	1.34	1.19	1.65	H 1
3.5	6.1	1.91	2.5	1.57	1.23	1.86	H 2
4	7	2.17	2.7	1.79	1.51	2.14	H 2
5	8.8	2.68	3.4	2.24	2.12	2.75	H 2

Nominal dimension	Length (l)	
	min.	max.
5	4.62	5.38
6	5.62	6.38
7	6.55	7.45
8	7.55	8.45
10	9.55	10.45
12	11.45	12.55
14	13.45	14.55
16	15.45	16.55

Nominal dimension	Length (l)	
	min.	max.
18	17.45	18.55
20	19.35	20.65
22	21.35	22.65
25	24.35	25.65
30	29.35	30.65
35	34.20	35.80
40	39.20	40.80



E 1413
EJOT PT® with countersunk head
cross-slot (Phillips), zinc-plated

Diameter (mm) \ Lenth (mm)	2.2	2.5	3.0	3.5	4.0
6	E1413KA/VZ226	E1413KA/VZ256			
8	E1413KA/VZ228	E1413KA/VZ258	E1413KA/VZ308	E1413KA/VZ358	
10	E1413KA/VZ2210	E1413KA/VZ2510	E1413KA/VZ3010	E1413KA/VZ3510	E1413KA/VZ4010
12	E1413KA/VZ2212	E1413KA/VZ2512	E1413KA/VZ3012	E1413KA/VZ3512	E1413KA/VZ4012
14	E1413KA/VZ2214	E1413KA/VZ2514	E1413KA/VZ3014	E1413KA/VZ3514	E1413KA/VZ4014
16	E1413KA/VZ2216	E1413KA/VZ2516	E1413KA/VZ3016	E1413KA/VZ3516	E1413KA/VZ4016
18		E1413KA/VZ2518	E1413KA/VZ3018	E1413KA/VZ3518	E1413KA/VZ4018
20		E1413KA/VZ2520	E1413KA/VZ3020	E1413KA/VZ3520	E1413KA/VZ4020
22				E1413KA/VZ3522	E1413KA/VZ4022
25				E1413KA/VZ3525	

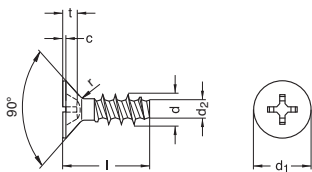

Diameter (d)	c max.	d ₁ Nominal dimension	d ₂ Nominal dimension	r Nominal dimension	Pitch (P)	t		Tool size
						min.	max.	
2.2	0.35	3.8	1.25	–	0.98	0.95	1.25	H 1
2.5	0.55	4.7	1.4	1	1.12	0.97	1.43	H 1
3	0.55	5.5	1.66	1.2	1.34	1.10	1.56	H 1
3.5	0.65	7.3	1.91	1.4	1.57	1.33	1.96	H 2
4	0.7	8.4	2.17	1.6	1.79	1.59	2.22	H 2

Nominal dimension	Lenth (l)	
	min.	max.
6	5.62	6.38
8	7.55	8.45
10	9.55	10.45
12	11.45	12.55
14	13.45	14.55

Nominal dimension	Length (l)	
	min.	max.
16	15.45	16.55
18	17.45	18.55
20	19.35	20.65
22	21.35	22.65
25	24.35	25.65

Standard product range



E 1452
EJOT PT® with button head
TORX® hexalobular drive, zinc-plated

Diameter (mm) \ Length (mm)	2.2	2.5	3.0	3.5	4.0
6	E1452K/VZ226	E1452K/VZ256	E1452K/VZ306		
8	E1452K/VZ228	E1452K/VZ258	E1452K/VZ308		E1452K/VZ408
10	E1452K/VZ2210	E1452K/VZ2510	E1452K/VZ3010	E1452K/VZ3510	E1452K/VZ4010
12	E1452K/VZ2212	E1452K/VZ2512	E1452K/VZ3012	E1452K/VZ3512	E1452K/VZ4012
14	E1452K/VZ2214	E1452K/VZ2514	E1452K/VZ3014	E1452K/VZ3514	E1452K/VZ4014
16	E1452K/VZ2216		E1452K/VZ3016	E1452K/VZ3516	E1452K/VZ4016
18			E1452K/VZ3018	E1452K/VZ3518	E1452K/VZ4018
20			E1452K/VZ3020	E1452K/VZ3520	E1452K/VZ4020
22			E1452K/VZ3022	E1452K/VZ3522	E1452K/VZ4022
25			E1452K/VZ3025	E1452K/VZ3525	E1452K/VZ4025
30				E1452K/VZ3530	E1452K/VZ4030
35					E1452K/VZ4035
40					E1452K/VZ4040

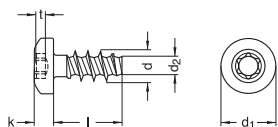

Diameter (d)	d ₁ Nominal dimension	d ₂ Nominal dimension	k Nominal dimension	Pitch (P)	t		Tool size
					min.	max.	
2.2	4	1.25	1.4	0.98	0.70	0.85	TX 6
2.5	4.2	1.4	1.6	1.12	0.70	0.85	TX 7
3	5.6	1.66	2.1	1.34	1.00	1.30	TX 10
3.5	6.9	1.91	2.3	1.57	1.10	1.40	TX 10
4	7.5	2.17	2.6	1.79	1.25	1.70	TX 20

Nominal dimension	Length (l)	
	min.	max.
6	5.62	6.38
8	7.55	8.45
10	9.55	10.45
12	11.45	12.55
14	13.45	14.55
16	15.45	16.55
18	17.45	18.55

Nominal dimension	Length (l)	
	min.	max.
20	19.35	20.65
22	21.35	22.65
25	24.35	25.65
30	29.35	30.65
35	34.20	35.80
40	39.20	40.80

Self-tapping fasteners for plastics

EJOT DELTA PT®

The DELTA PT® is a further development and improvement of the PT® screw oriented towards challenging new materials. The EJOT DELTA PT® is the perfect technology for thermoplastics and highly reinforced plastics in particular. The ongoing change of materials allows the use of plastics whose use had, until a few years ago, been limited to cast light metals. These plastics have high strengths and are suitable for high temperature ranges. This opens up new fields of applications that require new screw joint technologies in order to apply the high stresses and strict requirements to the fastener as well.



Large core cross-section

- High tensile strength and torsional strength
- Particularly suitable for high-strength plastics

Optimized core contour

- Ideal and low-damage material discharge
- Strong self-locking effect to prevent loosening of the joint
- High thread overlap even with shallow screw-in depths

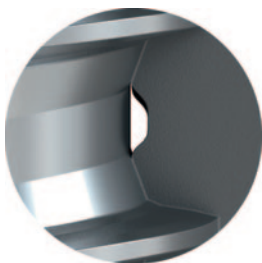

Angle geometry

- Angle combination (20°/30°) for low radial stress
- Transition angle on thread ridge increases bending strength
- Supports lightweight construction and reduced tube diameters

Advantages of the EJOT DELTA PT®:

- High torsional and tensile strength
- Easy attachment for safe assembly
- High dynamic safety
- Good heat dissipation
- Thin-walled component design
- Shallow screw-in depths required



Designs suitable for plastics

The design of the screw-in tube in connection with the clamping part has a crucial influence on the durability of the screw connection. The DELTA PT® thread was specially developed for the self-tapping connection of thermoplastics.

The combination of a special thread pitch and shaped flank angle enables especially high-performance connections in accordance with the following design recommendations.

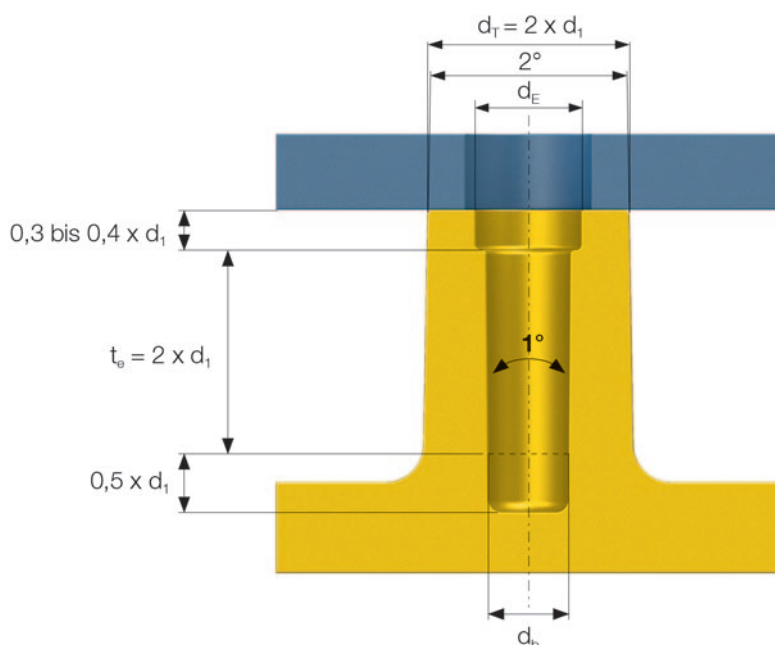

Hole diameter (d_b) = $0.8 \times d_1 \pm 0.05 \text{ mm}$

Screw-in depth (t_b) = $2 \times d_1$

d_1 = nominal diameter of the screw

$d_E = d_1 \times 1.05$

For high-performance/technical thermoplastics, the hole diameter can be increased up to $d_b = 0.88 \times d_1$. The draft angle in the pilot hole should be kept as low as possible, but no more than 1°.

Note

This design recommendation was developed on the basis of laboratory tests. In practice, deviations may occur due to the different properties of components. The same applies to the recommendation above concerning the screw-in point; reinforcement with ribs or a flat variant with tubes protruding to the rear is also possible.

Standard product range



E 5451

DELTA PT[®] with button head and pressed-on washer
TORX PLUS[®], Autosert drive, zinc-plated

Diameter (mm) \ Length (mm)	2.2		2.5		3.0		3.5		4.0		5.0		6.0	
	6	E5451VZ226	E5451VZ256	E5451VZ306						E5451VZ408				
8	E5451VZ228	E5451VZ258	E5451VZ308											
10	E5451VZ2210	E5451VZ2510	E5451VZ3010	E5451VZ3510	E5451VZ4010	E5451VZ5010								
12	E5451VZ2212	E5451VZ2512	E5451VZ3012	E5451VZ3512	E5451VZ4012	E5451VZ5012	E5451VZ6012							
14	E5451VZ2214	E5451VZ2514	E5451VZ3014	E5451VZ3514	E5451VZ4014	E5451VZ5014	E5451VZ6014							
16	E5451VZ2216	E5451VZ2516	E5451VZ3016	E5451VZ3516	E5451VZ4016	E5451VZ5016	E5451VZ6016							
18			E5451VZ3018	E5451VZ3518	E5451VZ4018	E5451VZ5018	E5451VZ6018							
20			E5451VZ3020	E5451VZ3520	E5451VZ4020	E5451VZ5020	E5451VZ6020							
22			E5451VZ3022	E5451VZ3522	E5451VZ4022	E5451VZ5022	E5451VZ6022							
25			E5451VZ3025	E5451VZ3525	E5451VZ4025	E5451VZ5025	E5451VZ6025							
30				E5451VZ3530	E5451VZ4030	E5451VZ5030	E5451VZ6030							
35				E5451VZ3535	E5451VZ4035	E5451VZ5035								
40					E5451VZ4040	E5451VZ5040								
50						E5451VZ5050								

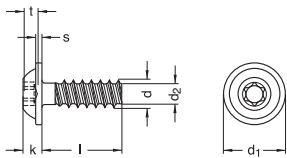

Diameter (d)	d ₁ max.	d ₂ Nominal dimension	k Nominal dimension	s Nominal dimension	Pitch (P)	t		Tool size
						min.	max.	
2.2	5	1.51	1.6	0.6	0.85	0.65	0.85	TX 6
2.5	5.5	1.72	1.9	0.7	0.95	0.80	1.00	TX 8
3	6.5	2.09	2.3	0.8	1.12	1.00	1.30	TX 10
3.5	7.5	2.45	2.7	0.9	1.29	1.10	1.50	TX 15
4	9	2.81	3.1	1	1.46	1.40	1.80	TX 20
4.5	10	3.17	3.2	1.1	–	1.40	1.80	TX 20
5	11	3.53	3.5	1.2	1.8	1.50	1.90	TX 25
6	13.5	4.26	4.2	1.4	2.14	1.90	2.40	TX 30

Nominal dimension	Length (l)	
	min.	max.
6	5.62	6.38
8	7.55	8.45
10	9.55	10.45
12	11.45	12.55
14	13.45	14.55
16	15.45	16.55
18	17.45	18.55

Nominal dimension	Length (l)	
	min.	max.
20	19.35	20.65
22	21.35	22.65
25	24.35	25.65
30	29.35	30.65
35	34.20	35.80
40	39.20	40.80
50	49.20	50.80



E 5452
EJOT DELTA PT® with button head
TORX PLUS®, zinc-plated

Diameter (mm) \ Length (mm)	2.2	2.5	3.0	3.5	4.0	5.0
6		E5452VZ256	E5452VZ306			
8	E5452VZ228	E5452VZ258	E5452VZ308	E5452VZ358	E5452VZ408	
10	E5452VZ2210	E5452VZ2510	E5452VZ3010	E5452VZ3510	E5452VZ4010	E5452VZ5010
12	E5452VZ2212	E5452VZ2512	E5452VZ3012	E5452VZ3512	E5452VZ4012	E5452VZ5012
14	E5452VZ2214	E5452VZ2514	E5452VZ3014	E5452VZ3514	E5452VZ4014	E5452VZ5014
16	E5452VZ2216	E5452VZ2516	E5452VZ3016	E5452VZ3516	E5452VZ4016	E5452VZ5016
18	E5452VZ2218	E5452VZ2518	E5452VZ3018	E5452VZ3518	E5452VZ4018	E5452VZ5018
20	E5452VZ2220	E5452VZ2520	E5452VZ3020	E5452VZ3520	E5452VZ4020	E5452VZ5020
22	E5452VZ2222	E5452VZ2522	E5452VZ3022	E5452VZ3522	E5452VZ4022	E5452VZ5022
25		E5452VZ2525	E5452VZ3025	E5452VZ3525	E5452VZ4025	E5452VZ5025
30			E5452VZ3030	E5452VZ3530	E5452VZ4030	E5452VZ5030
35				E5452VZ3535	E5452VZ4035	E5452VZ5035
40					E5452VZ4040	E5452VZ5040
50						E5452VZ5050

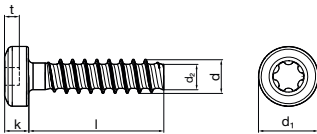

Diameter (d)	c max.	d ₁ max.	d ₂ Nominal dimension	r Nominal dimension	Pitch (P)	t		Tool size
						min.	max.	
22	1.6	3.9	1.51	0.35	0.85	0.65	0.85	6
25	1.9	4.4	1.72	0.4	0.95	0.80	1.00	8
30	2.3	5.3	2.09	0.5	1.12	1.00	1.30	10
35	2.7	6.1	2.45	0.5	1.29	1.10	1.50	15
40	3.1	7	2.81	0.6	1.46	1.40	1.80	20
50	3.5	8.8	3.53	0.7	1.8	1.50	1.90	25

Nominal dimension	Length (l)	
	min.	max.
6	5.625	6.375
8	7.55	8.45
10	9.55	10.45
12	11.45	12.55
14	13.45	14.55
16	15.45	16.55
18	17.45	18.55

Nominal dimension	Length (l)	
	min.	max.
20	19.35	20.65
22	21.35	22.65
25	24.35	25.65
30	29.35	30.65
35	34.2	35.8
40	39.2	40.8
50	49.2	50.8

Standard product range



E 5454
DELTA PT® with countersunk head
TORX PLUS®, Autosert drive, zinc-plated

Diameter (mm) \ Length (mm)	2.5	3.0	3.5	4.0
8	E5454VZ258			
10	E5454VZ2510	E5454VZ3010	E5454VZ3510	E5454VZ4010
12	E5454VZ2512	E5454VZ3012	E5454VZ3512	E5454VZ4012
14				E5454VZ4014
16		E5454VZ3016	E5454VZ3516	

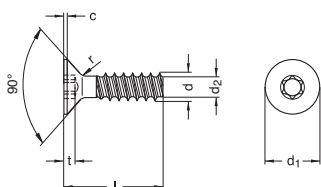

Diameter (d)	c max.	d ₁ max.	d ₂ Nominal dimension	r Nominal dimension	Pitch (P)	t		Tool size
						min.	max.	
2.5	0.55	5	1.72	1	0.95	0.70	0.90	TX 8
3	0.55	6	2.09	1.2	1.12	0.75	1.00	TX 10
3.5	0.65	7	2.45	1.4	1.29	0.95	1.30	TX 15
4	0.7	8	2.81	1.6	1.46	1.10	1.45	TX 20

Nominal dimension	Length (l)	
	min.	max.
8	7.55	8.45
10	9.55	10.45
12	11.45	12.55

Nominal dimension	Length (l)	
	min.	max.
14	13.45	14.55
16	15.45	16.55
20	19.35	20.65

Alternative head shapes, lengths, or special parts with EJOT DELTA PT® thread are available on request. Contact our technical support. We will be happy to assist you.

Other variants:



- DELTA PT® DS**
- Thread form: DS (DuroSet)
 - Suitable for especially hard, optimized, and brittle materials
 - Cutting edge allows the same optimal processing



- DELTA PT® P**
- Extremely lightweight materials
 - Length extension = less relaxation
 - Weight saving
 - Base material: plastic

Self-tapping fasteners for plastics

AMTEC® screw

AMTEC® stands for After Molding TEChnology from Böllhoff – the economical solution for self-tapping fasteners for thermoplastics. For the design of this screw a trilobular screw cross-section was selected on the basis of a large number of tests to achieve the best possible results: low insertion torque combined with high overtorque for reliable screw connections and high pull-out strength. AMTEC® screws with a 30° thread flank have proven their performance over time.

The AMTEC® screw has a wide range of application, making it suitable for challenging dynamic applications too. Since the AMTEC® screw allows up to ten repeat fastenings, it is also ideal for use in maintenance applications.

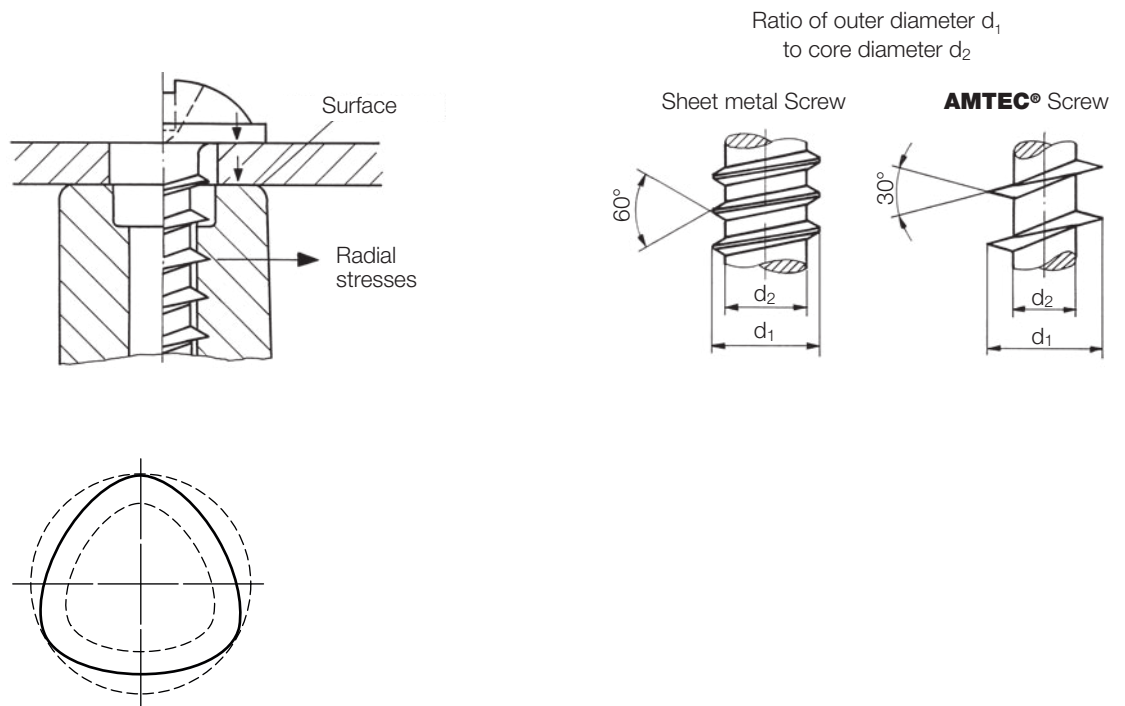

The trilobular cross-section of AMTEC® screws reduces insertion torques and creates reservoirs in which displaced plastic can flow into. In addition to fast assembly, the high thread pitch allows self-locking and a large surface overlap, which reduces surface pressure, counteracting plastic's tendency towards relaxation.

Advantages

- Economical
- Low insertion torques
- High pullout forces
- Self-locking

For proper use, it is essential to observe the design notes. The technical guidelines for the hole properties must be taken into account for AMTEC® screws.

Design recommendations AMTEC® screws

Materials	Borehole diameter d_1	Cam outer diameter D_A	Insertion depth t_E
PE	$0.7 - 0.75 \cdot d$	$2 \times d$	$2.0 - 2.5 \cdot d$
PP	$0.72 - 0.76 \cdot d$	$2 - 2.5 \cdot d$	$2.0 - 2.5 \cdot d$
PET	$0.75 \cdot d$	$1.9 \cdot d$	$1.9 \cdot d$
PET GF	$0.8 \cdot d$	$1.85 \cdot d$	$1.8 \cdot d$
POM	$0.77 \cdot d$	$2 - 2.3 \cdot d$	$2 \cdot d$
SAN	$0.78 \cdot d$	$2 \cdot d$	$2 \cdot d$
PA 6	$0.76 \cdot d$	$1.8 - 2.2 \cdot d$	$1.8 \cdot d$
PA 6 GF	$0.8 \cdot d$	$2.0 - 2.5$	$1.9 - 2.4 \cdot d$
PA 6.6	$0.75 \cdot d$	$1.9 \cdot d$	$1.8 \cdot d$
PA 6.6 GF	$0.82 \cdot d$	$2.0 - 2.4$	$1.9 \cdot d$
PBT	$0.75 \cdot d$	$1.9 \cdot d$	$1.9 \cdot d$
PBT GF	$0.8 \cdot d$	$1.85 \cdot d$	$1.8 \cdot d$
ABS	$0.76 - 0.8 \cdot d$	$2.0 - 2.6 \cdot d$	$2.0 - 2.5 \cdot d$
ABS/PC	$0.8 \cdot d$	$2.0 \cdot d$	$2.0 \cdot d$
PS	$0.8 - 0.84 \cdot d$	$2.0 - 2.5 \cdot d$	$2.0 - 2.4 \cdot d$
PMMA	$0.85 \cdot d$	$2.0 \cdot d$	$2.0 \cdot d$
PC	0.85	$2.5 \cdot d$	$2.2 - 2.6 \cdot d$

Standard product range



B 52004
AMTEC® screw with button head
cross-slot (Pozidriv), zinc-plated

Diameter (mm) \ Length (mm)	2.5	3.0	3.5	4.0	5.0	6.0
6	520042,56	5200436		5200446		
8	520042,58	5200438	520043,58	5200448		
10	520042,510	52004310	520043,510	52004410		
12		52004312	520043,512	52004412		
14					52004514	
16		52004316	520043,516	52004416	52004516	52004616
18		52004318		52004418		52004618
20			520043,520	52004420	52004520	52004620
25				52004425	52004525	52004625
30						52004630

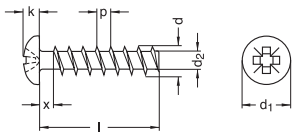

Diameter (d)	d ₁ Nominal dimension	d ₂		k Nominal dimension	Pitch (P)	x max.	Tool size
		min.	max.				
2.5	4.4	1.7	1.6	1.7	1.12	2.2	Z 1
3	5.3	2.1	2.0	2	1.35	2.8	Z 1
3.5	6.1	2.3	2.2	2.5	1.6	3.2	Z 2
4	7	2.5	2.4	2.7	1.8	3.6	Z 2
5	8.8	3.0	2.9	3.4	2.2	4.6	Z 2
6	10.5	3.5	3.4	4	2.6	5.6	Z 3

Nominal dimension	Length (l)	
	min.	max.
6	5.40	6.60
8	7.25	8.75
10	9.25	10.75
12	11.10	12.90
14	13.10	14.90

Nominal dimension	Length (l)	
	min.	max.
16	15.10	16.90
20	18.95	21.05
25	23.95	26.05
30	28.95	31.05

Standard product range



B 52004

AMTEC® screw with button head and hexalobular drive
zinc-plated

Diameter (mm) \ Length (mm)	2.5	3.0	3.5	4.0	5.0
6	52004TXVZ2,56	52004TXVZ36			
8	52004TXVZ2,58	52004TXVZ38	52004TXVZ3,58	52004TXVZ48	
10	52004TXVZ2,510	52004TXVZ310	52004TXVZ3,510	52004TXVZ410	
12		52004TXVZ312	52004TXVZ3,512	52004TXVZ412	
14	52004TXVZ2,514	52004TXVZ314			
16		52004TXVZ316	52004TXVZ3,516	52004TXVZ416	52004TXVZ516
20			52004TXVZ3,520	52004TXVZ420	52004TXVZ520
25				52004TXVZ425	

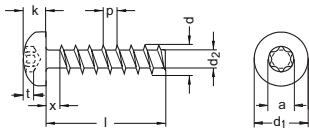

Diameter (d)	a max.	d ₁ Nominal dimension	d ₂		k Nominal dimension	Pitch (P)	t		x max.	Tool size
			min.	max.			min.	max.		
2.5	2.40	4.7	1.7	1.6	1.6	1.12	0.75	1.00	2.2	TX 8
3	2.80	5.6	2.0	1.9	2.1	1.35	1.00	1.30	2.8	TX 10
3.5	2.80	6.5	2.2	2.1	2.3	1.60	1.10	1.40	3.2	TX 10
4	3.95	7.5	2.4	2.3	2.6	1.80	1.25	1.70	3.6	TX 20
5	3.95	9.2	2.9	2.9	2.9	2.20	1.40	1.80	4.6	TX 20

Nominal dimension	Length (l)		Nominal dimension	Length (l)	
	min.	max.		min.	max.
6	5.40	6.60	14	13.10	14.90
8	7.25	8.75	16	15.10	16.90
10	9.25	10.75	20	18.95	21.05
12	11.10	12.90	25	23.95	26.05



B 52005

**AMTEC® screw with countersunk head and cross-slot Z (Pozidriv)
zinc-plated**

Diameter (mm) \ Length (mm)	2.5	3.0	3.5	4.0	5.0	6.0
6		5200536				
8	520052,58	5200538				
10		52005310				
12		52005312	520053,512	52005412		
14						
16		52005316		52005416		
20				52005420	52005520	
25				52005425		52005625

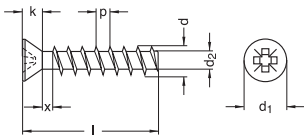

Diameter (d)	d ₁ Nominal dimension	Nominal dimension	d ₂		k Nominal dimension	Pitch (P)	t		x max.	Tool size
			min.	max.			min.	max.		
2.5	4.7	1.6	1.5	1.7	1.70	1.12	1.09	1.34	2.2	Z 1
3	5.5	2	1.9	2.1	1.80	1.35	1.20	1.73	2.8	Z 2
3.5	7.3	2.2	2.1	2.3	2.56	1.60	1.47	2.06	3.2	Z 2
4	8.4	2.4	2.3	2.5	2.90	1.80	1.70	2.35	3.6	Z 2
5	9.3	2.9	2.8	3.0	3.00	2.20	2.06	2.52	4.6	Z 2
6	11.3	3.4	3.3	3.5	3.80	2.60	2.10	3.10	5.6	Z 2

Nominal dimension	Length (l)		Nominal dimension	Length (l)	
	min.	max.		min.	max.
8	7.25	8.75	16	15.10	16.90
10	9.25	10.75	20	18.95	21.05
12	11.10	12.90	25	23.95	26.05
6	5.40	6.60			

Standard product range



B 52005

AMTEC® screw with countersunk head and hexalobular drive
zinc-plated

Diameter (mm) \ Length (mm)	2.5	3.0	3.5	4.0
8	52005TXVZ2,58	52005TXVZ38		
10		52005TXVZ310	52005TXVZ3,510	
12		52005TXVZ312	52005TXVZ3,512	52005TXVZ412
16		52005TXVZ316		52005TXVZ416

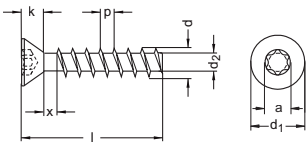

Diameter (d)	a max.	d ₁ Nominal dimension	Nominal dimension	d ₂		k Nominal dimension	Pitch (P)	t		x max.	Tool size
				min.	max.			min.	max.		
2.5	2.40	4.7	1.6	1.5	1.7	1.70	1.12	0.75	1.0	2.2	TX 8
3	2.40	5.5	2	1.9	2.1	1.80	1.35	0.80	1.0	2.8	TX 8
3.5	3.35	7.3	2.2	2.1	2.3	2.56	1.60	1.00	1.3	3.2	TX 15
4	3.95	8.4	2.4	2.3	2.5	2.90	1.80	1.25	1.7	3.6	TX 20

Nominal dimension	Length (l)		Nominal dimension	Length (l)	
	min.	max.		min.	max.
8	7.25	8.75	12	11.10	12.90
10	9.25	10.75	16	15.10	16.90



B 52006
AMTEC® screw with button flange head
cross-slot Z (Pozidriv), zinc-plated

Diameter (mm) \ Length (mm)	3.0	3.5	4.0	5.0
6	5200636			
8	5200638			
10	52006310	520063,51	52006410	
12				
16			52006416	
20		520063,52		52006520
30				52006530

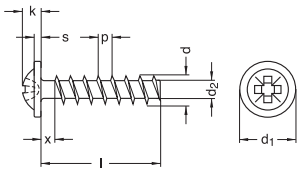

Diameter (d)	d ₁ Nominal dimension	Nominal dimension	d ₂		k Nominal dimension	s Nominal dimension	Pitch (P)	t		x max.	Tool size
			min.	max.				min.	max.		
3	6	2	1.9	2.1	2.1	0.7	1.35	1.26	1.51	2.8	Z 1
3.5	7	2.2	2.1	2.3	2.4	0.8	1.60	1.08	1.54	3.2	Z 2
4	8	2.4	2.3	2.5	2.5	0.9	1.80	1.40	1.86	3.6	Z 2

Nominal dimension	Length (l)	
	min.	max.
6	5.40	6.60
8	7.25	8.75
10	9.25	10.75

Nominal dimension	Length (l)	
	min.	max.
16	15.10	16.90
20	18.95	21.05
30	28.95	31.0

Standard product range



B 52006

**AMTEC® screw with button head and pressed washer
hexalobular drive, zinc-plated**

Diameter (mm) \ Length (mm)	2.5	3.0	3.5	4.0
6	52006TXVZ2,56	52006TXVZ36		
8	52006TXVZ2,58	52006TXVZ38	52006TXVZ3,58	52006TXVZ48
10	52006TXVZ2,510	52006TXVZ310	52006TXVZ3,510	52006TXVZ410
12		52006TXVZ312	52006TXVZ3,512	52006TXVZ412
16				52006TXVZ416
20				52006TXVZ420

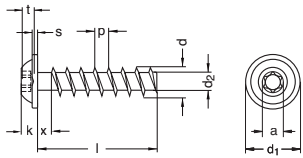

Diameter (d)	a max.	d ₁ Nominal dimension	Nominal dimension	d ₂		k Nominal dimension	s Nominal dimension	Pitch (P)	t		x max.	Tool size
				min.	max.				min.	max.		
2.5	2.40	5	1.6	1.5	1.7	1.5	0.5	1.12	0.75	1.0	2.2	TX 6
3	2.80	6	2	1.9	2.1	2.1	0.6	1.35	1.00	1.3	2.8	TX 10
3.5	2.80	7	2.2	2.1	2.3	2.4	0.7	1.60	1.10	1.4	3.2	TX 10
4	3.95	8	2.4	2.3	2.5	2.6	0.8	1.80	1.25	1.7	3.6	TX 20

Nominal dimension	Length (l)	
	min.	max.
6	5.40	6.60
8	7.25	8.75
10	9.25	10.75

Nominal dimension	Length (l)	
	min.	max.
12	11.10	12.90
16	15.10	16.90
20	18.95	21.05

Self-tapping fasteners for sheet metal



QUICK FLOW® thin sheet metal screws B 52030

If the total thickness of the parts to be screwed (sheets) is lower than the thread pitch of the tapping screws according to DIN EN ISO 1478 (wobble limit), then it is necessary to use additional joining elements; otherwise a tight joint is not possible.

Thin sheet metal screws such as QUICK FLOW® offer an economical alternative.

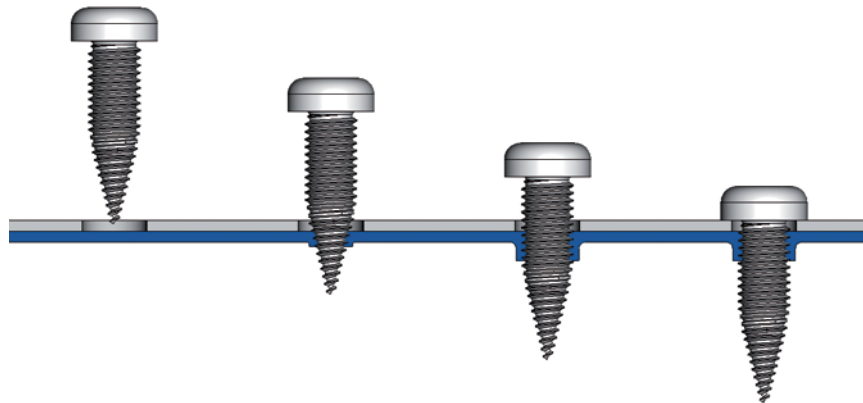

The stable spiral tip allows screw connections even without pre-drilling holes. The geometry of the screw tip first forms a pull-through in the thin-walled sheet and then forms the reusable metric pilot thread. The fine thread pitch of the QUICK FLOW® has sufficient overlap with the pilot threads that are formed. Furthermore, automated assembly is possible.

High overtorques provide the required reliability. There is no need for additional nut elements.

Advantages

- No pre-drilling or stamping of the material
- No need for nut elements
- Short cycle times thanks to fast, automated assembly
- High process reliability during assembly thanks to high overtorques
- Repeated loosening and tightening possible
- Secure, durable screw connection

Standard product range



QUICK FLOW® thin sheet metal screws

B 52030

case hardened with hexalobular drive, zinc-plated

Diameter (mm) \ Length (mm)	4.0	5.0	6.0
12	52030C/TXB2412		
17	52030C/TXB2417	52030C/TXB2517	
20		52030C/TXB2520	52030C/TXB2620
28			52030C/TXB2628

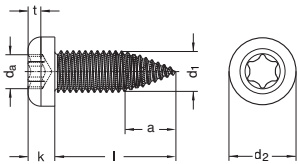

Diameter (d)	a max.	d ₁ Nominal dimension	d ₂ Nominal dimension	d _a Nominal dimension	k Nominal dimension	t		Tool size
						min.	max.	
M4	7.0	4	8	3.95	3.1	1.27	1.66	TX 20
M5	9.0	5	9.5	4.50	3.7	1.52	1.91	TX 25
M6	10.5	6	12	5.60	4.6	2.02	2.42	TX 30

Nominal dimension	Length (l)		Nominal dimension	Length (l)	
	min.	max.		min.	max.
12	11.7	12.3	20	19.6	20.4
17	16.6	17.4	28	27.5	28.5

Self-tapping fasteners for solid metal



B 7500 Thread forming screws, Duo form

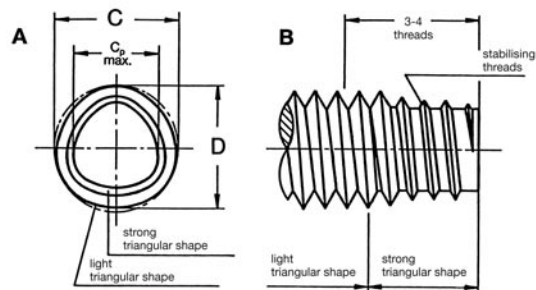

Thread forming screws are screwed into a pre-drilled hole in solid metal components. The hole diameter is between the core diameter and the pitch diameter of the thread. The threaded end of the screw is tapered to facilitate the thread forming start. The mating thread is pressed into the hole by its non-circular shape (lobulation). One group of thread forming screws is standardized in DIN 7500. In addition to the Duo form screw shown, there are different versions for the thread forming zone – different principles are possible depending on the production specifics. At Böllhoff, the B 7500 is standardized and guarantees consistent assembly parameters.

Thread forming screws can be used in the following materials, among others:

- Steel up to a tensile strength of 450 N/mm²
- Aluminum
- Copper alloys
- Die-cast zinc

No chips are produced during the processing of thread forming screws. The thread that is grooved is hardened and compatible with ISO metric bolt threads. For repair, a normal metric screw can be used, for example. These have a relatively large pitch and a small core diameter. As with other self-tapping joints, the B 7500 offers self-locking properties and allows up to ten repeat fastenings.

Advantages

- No thread cutting, no chips
- No locking elements necessary
- Good vibration resistance
- High pullout resistance



Technical information

d	View A				
	Radius C		Dimension D		Radius C _p max.
	max.	min.	max.	min.	
M 2	2.06	1.98	2.02	1.94	1.67
M 2.5	2.57	2.48	2.52	2.43	2.13
M 3	3.07	2.98	3.02	2.93	2.58
M 3.5	3.58	3.48	3.52	3.42	2.99
M 4	4.08	3.98	4.01	3.91	3.40
M 5	5.09	4.98	5.01	4.90	4.31
M 6	6.10	5.97	6.00	5.87	5.12

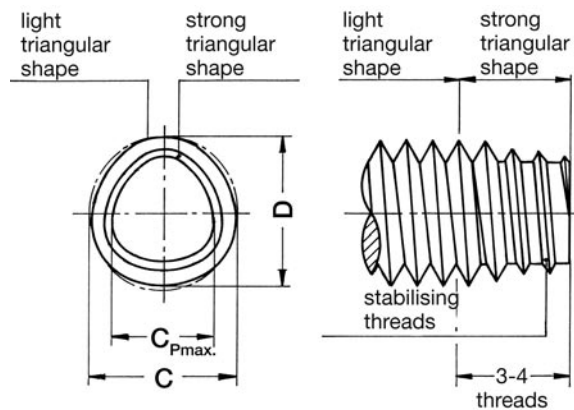

Installation recommendation

d	Core hole diameter poured		Minimum eye diameter H	Minimum edge distance J	Bore depth K	Insertion depth L
	A	B				
M 2	1.88 ⁺⁰ _{-0.05}	1.79 ⁺⁰ _{-0.05}	3.20	1.00	5.00	4.00
M 2.5	2.35 ⁺⁰ _{-0.05}	2.25 ⁺⁰ _{-0.05}	4.20	1.20	6.00	5.00
M 3	2.80 ⁺⁰ _{-0.05}	2.70 ⁺⁰ _{-0.05}	5.00	1.30	7.00	6.00
M 3.5	3.25 ⁺⁰ _{-0.05}	3.15 ⁺⁰ _{-0.05}	5.80	1.60	8.00	7.00
M 4	3.70 ⁺⁰ _{-0.10}	3.60 ⁺⁰ _{-0.10}	6.70	1.80	9.00	8.00
M 5	4.75 ⁺⁰ _{-0.10}	4.55 ⁺⁰ _{-0.05}	8.30	2.10	11.00	10.00
M 6	5.65 ⁺⁰ _{-0.10}	5.45 ⁺⁰ _{-0.10}	10.00	2.60	13.00	12.00

d	P	Thread overlapping																drilling diameter
		100%	95%	90%	85%	80%	75%	70%	65%	60%	55%	50%	45%	40%	35%	30%		
M 2	0.4	1.76	1.77	1.78	1.79	1.80	1.82	1.83	1.84	1.85	1.87	1.88	1.89	1.90	1.91	1.93		
M 2.5	0.45	2.21	2.22	2.24	2.25	2.27	2.28	2.30	2.31	2.33	2.34	2.35	2.37	2.38	2.40	2.41		
M 3	0.5	2.68	2.69	2.71	2.72	2.74	2.76	2.77	2.79	2.81	2.82	2.84	2.85	2.87	2.89	2.90		
M 3.5	0.6	3.11	3.13	3.15	3.17	3.19	3.21	3.23	3.25	3.27	3.29	3.31	3.33	3.34	3.36	3.38		
M 4	0.7	3.55	3.57	3.59	3.61	3.64	3.66	3.68	3.70	3.73	3.75	3.77	3.80	3.82	3.84	3.86		
M 5	0.8	4.48	4.51	4.53	4.56	4.58	4.61	4.64	4.66	4.69	4.71	4.74	4.77	4.79	4.82	4.84		
M 6	1.0	5.35	5.38	5.42	5.45	5.48	5.51	5.55	5.58	5.61	5.64	5.68	5.71	5.74	5.77	5.81		

Since the data given figures are based on a linear relationship between bore diameter and percentage, smaller deviations may occur in practice below 70%. Optimal figures can only be found by laboratory tests.

Recommended core hole diameters for ductile materials

d	M 2			M 2,5			M 3			M 3,5			M 4			M 5			M 6		
Material thickness or screw- in depth	recommended tolerance field H11																				
	St	Al	Cu	St	Al	Cu	St	Al	Cu	St	Al	Cu	St	Al	Cu	St	Al	Cu	St	Al	Cu
0.8	1.8			2.25																	
0.9	1.8			2.25																	
1	1.8			2.25			2.7														
1.2	1.8			2.25			2.7			3.15											
1.5	1.8			2.25			2.7			3.15			3.6			4.5					
1.6	1.8			2.25			2.7			3.2			3.6			4.5					
1.7	1.8			2.25			2.7			3.2			3.6			4.5					
1.8	1.85			2.25			2.75 2.7 2.7			3.2			3.6			4.5					
2	1.85			2.25			2.75 2.7 2.7			3.2			3.6			4.5			5.4		
2.2	1.85			2.25			2.75			3.2			3.6			4.5			5.4		
2.5	1.85			2.25			2.75			3.2			3.65 3.6 3.6			4.5			5.4		
3	1.85			2.3			2.75			3.2			3.65 3.6 3.6			4.5			5.45		
3.2	1.85			2.3			2.75			3.2			3.65 3.6 3.6			4.55 4.5 4.5			5.45		
3.5	1.85			2.3			2.75			3.2			3.65			4.55			5.45		
4				2.3			2.75			3.2			3.65			4.55			5.5 5.45 5.45		
5				2.3			2.75			3.2 3.25 3.25			3.7 3.65 3.65			4.6			5.5 5.45 5.45		
5.5							2.75			3.25			3.7 3.65 3.65			4.6			5.5		
6							2.75			3.2 3.25 3.25			3.7 3.65 3.65			4.6			5.5		
6.3										3.25			3.7			4.65			5.5		
6.5													3.7			4.65			5.5		
7													3.7			4.65			5.55 5.5 5.5		
7.5													3.7			4.65			5.55 5.5 5.5		
8 to ≤ 10																4.65			5.55		

From the spreadsheet: St = DC01 and S235JR

Al = Al 99,5 F 13 and AlMn F 10

Cu = E-Cu 57 F 30, E-Cu 58 F 30 and CuZn F 38

Standard product range



B 7500 CE
Button head, cross-slot Z (Pozidriv)
zinc-plated

Diameter (mm) \ Length (mm)	2.0	2.5	3.0	3.5	4.0	5.0	6.0
4		B7500CEV12,54					
5	B7500CEV125	B7500CEV12,55	B7500CEV135				
6	B7500CEV126	B7500CEV12,56	B7500CEV136	B7500CEV13,56	B7500CEV146		
8	B7500CEV128	B7500CEV12,58	B7500CEV138	B7500CEV13,58	B7500CEV148	B7500CEV158	
10		B7500CEV12,510	B7500CEV1310	B7500CEV13,510	B7500CEV1410	B7500CEV1510	B7500CEV1610
12			B7500CEV1312	B7500CEV13,512	B7500CEV1412	B7500CEV1512	B7500CEV1612
16			B7500CEV1316	B7500CEV13,516	B7500CEV1416	B7500CEV1516	B7500CEV1616
20			B7500CEV1320	B7500CEV13,520	B7500CEV1420	B7500CEV1520	B7500CEV1620
25			B7500CEV1325	B7500CEV13,525	B7500CEV1425	B7500CEV1525	B7500CEV1625
30			B7500CEV1330		B7500CEV1430	B7500CEV1530	B7500CEV1630
35					B7500CEV1435	B7500CEV1535	B7500CEV1635
40						B7500CEV1540	B7500CEV1640

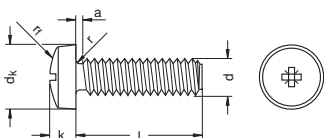

Diameter (d)	a max.	dk		Nominal dimension	k		rf	r min.	Tool size
		min.	max.		min.	max.			
M 2	0.8	3.70	4	1.6	1.48	1.72	4	0.10	Z 0
M 2.5	0.9	4.70	5	2.0	1.88	2.12	5	0.10	Z 1
M 3	1.0	5.70	6	2.4	2.28	2.52	6	0.10	Z 1
M 3.5	1.2	6.64	7	2.7	2.58	2.82	7	0.20	Z 2
M 4	1.4	7.64	8	3.1	2.95	3.25	8	0.20	Z 2
M 5	1.6	9.64	10	3.8	3.65	3.95	10	0.20	Z 2
M 6	2.0	11.57	12	4.6	4.45	4.75	12	0.25	Z 3

Nominal dimension	Length (l)		Nominal dimension	Length (l)	
	min.	max.		min.	max.
4	3.62	4.38	16	15.45	16.55
5	4.62	5.38	20	19.35	20.65
6	5.62	6.38	25	24.35	25.65
8	7.62	8.38	30	29.35	30.65
10	9.55	10.45	35	34.20	35.80
12	11.45	12.55	40	39.20	40.80



B 7500 DE
Hexagon head with flange
zinc-plated

Diameter (mm) \ Length (mm)	4.0	5.0	6.0	8.0
8	B7500DEV148		B7500DEV168	
10	B7500DEV1410	B7500DEV1510	B7500DEV1610	
12	B7500DEV1412	B7500DEV1512	B7500DEV1612	
16	B7500DEV1416	B7500DEV1516	B7500DEV1616	B7500DEV1816
20	B7500DEV1420	B7500DEV1520	B7500DEV1620	B7500DEV1820
25	B7500DEV1425	B7500DEV1525	B7500DEV1625	B7500DEV1825
30	B7500DEV1430	B7500DEV1530	B7500DEV1630	B7500DEV1830
35		B7500DEV1535	B7500DEV1635	B7500DEV1835
40		B7500DEV1540	B7500DEV1640	B7500DEV1840

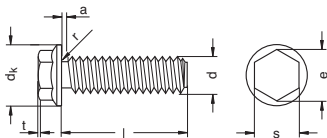

Diameter (d)	a max.	dk		Nominal dimension	k		e min.	r min.	s		t max.	Tool size
		min.	max.		min.	max.			min.	max.		
M 4	1.4	7.95	8.45	4.0	3.85	4.15	7.66	0.20	6.85	7	0.8	SW 7
M 5	1.6	9.75	10.25	4.5	4.35	4.65	8.77	0.20	7.85	8	0.8	SW 8
M 6	2.0	12.75	13.25	5.5	5.35	5.65	10.93	0.25	9.78	10	0.8	SW 10
M 8	2.5	16.75	17.25	6.8	6.62	6.98	14.23	0.40	12.73	13	1.0	SW 13

Nominal dimension	Length (l)	
	min.	max.
8	7.55	8.45
10	9.55	10.45
12	11.45	12.55
16	15.45	16.55
20	19.35	20.65

Nominal dimension	Length (l)	
	min.	max.
25	24,35	25,65
30	29,35	30,65
35	34,20	35,80
40	39,20	40,80

Standard product range



B 7500 EE
Cylinder head, hexagon socket
zinc-plated

Diameter (mm) \ Length (mm)	5.0	6.0	8.0
8	B7500EEV158		
10	B7500EEV1510		
12	B7500EEV1512		
16	B7500EEV1516		
20	B7500EEV1520	B7500EEV1620	B7500EEV1820
25	B7500EEV1525	B7500EEV1625	B7500EEV1825
30	B7500EEV1530	B7500EEV1630	B7500EEV1830
35		B7500EEV1635	B7500EEV1835
40		B7500EEV1640	B7500EEV1840

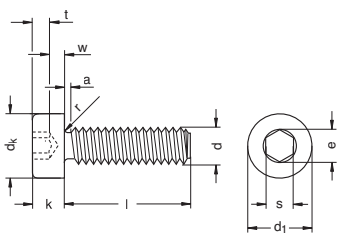

Diameter (d)	a max.	d _k		k		e min.	r min.	s			t min.	w min.	Tool size
		min.	max.	Nominal dimension	min.			Nominal dimension	min.	max.			
M 5	1.6	8.28	8.5	5	4.82	4.58	0.20	4	4.02	4.10	2.5	1.9	SW 4
M 6	2.0	9.78	10.0	6	5.70	5.72	0.25	5	5.02	5.14	3.0	2.3	SW 5
M 8	2.5	12.73	13.0	8	7.64	6.86	0.40	6	6.02	6.14	4.0	3.0	SW 6

Nominal dimension	Length (l)	
	min.	max.
8	7.55	8.45
10	9.55	10.45
12	11.45	12.55
16	15.45	16.55
20	19.35	20.65

Nominal dimension	Length (l)	
	min.	max.
25	24.35	25.65
30	29.35	30.65
35	34.20	35.80
40	39.20	40.80



B 7500 ME
Countersunk head, cross-slot Z (Pozidriv)
zinc-plated

Diameter (mm) \ Length (mm)	2.5	3.0	3.5	4.0	5.0	6.0
5	B7500MEV12,55					
6	B7500MEV12,56	B7500MEV136				
8	B7500MEV12,58	B7500MEV138	B7500MEV13,58	B7500MEV148		
10	B7500MEV12,510	B7500MEV1310	B7500MEV13,510	B7500MEV1410	B7500MEV1510	
12		B7500MEV1312	B7500MEV13,512	B7500MEV1412	B7500MEV1512	B7500MEV1612
16		B7500MEV1316	B7500MEV13,516	B7500MEV1416	B7500MEV1516	B7500MEV1616
20		B7500MEV1320	B7500MEV13,520	B7500MEV1420	B7500MEV1520	B7500MEV1620
25				B7500MEV1425	B7500MEV1525	B7500MEV1625
30				B7500MEV1430	B7500MEV1530	B7500MEV1630
35					B7500MEV1535	B7500MEV1635
40					B7500MEV1540	B7500MEV1640

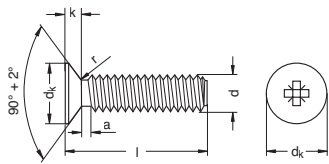

Diameter (d)	a max.	min.	dk max.	k max.	r max.	Tool size
M 2.5	0.9	4.40	4.7	1.50	0.6	Z 1
M 3	1.0	5.20	5.5	1.65	0.8	Z 1
M 3.5	1.2	6.94	7.3	2.35	0.9	Z 2
M 4	1.4	8.04	8.4	2.70	1.0	Z 2
M 5	1.6	8.94	9.3	2.70	1.3	Z 2
M 6	2.0	10.87	11.3	3.30	1.5	Z 3

Nominal dimension	Length (l)	
	min.	max.
5	4.62	5.38
6	5.62	6.38
8	7.55	8.45
10	9.55	10.45
12	11.45	12.55
16	15.45	16.55

Nominal dimension	Length (l)	
	min.	max.
20	19.35	20.65
25	24.35	25.65
30	29.35	30.65
35	34.20	35.80
40	39.20	40.80

Standard product range



B 7500 ME
Countersunk head, hexalobular drive
zinc-plated

Diameter (mm) \ Length (mm)	2.5	3.0	4.0	5.0	6.0
5					
6	B7500METXV12,56	B7500METXV136			
8	B7500METXV12,58	B7500METXV138	B7500METXV148		
10	B7500METXV12,510	B7500METXV1310	B7500METXV1410	B7500METXV1510	B7500METXV1610
12		B7500METXV1312	B7500METXV1412	B7500METXV1512	B7500METXV1612
16		B7500METXV1316	B7500METXV1416	B7500METXV1516	B7500METXV1616
20			B7500METXV1420	B7500METXV1520	B7500METXV1620
25			B7500METXV1425	B7500METXV1525	B7500METXV1625
30					B7500METXV1630

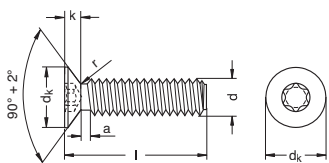

Diameter (d)	a max.	min.	dk max.	k max.	r max.	Tool size
M 2.5	0.9	4.40	4.7	1.50	0.6	TX 8
M 3	1.0	5.20	5.5	1.65	0.8	TX 10
M 4	1.4	8.04	8.4	2.70	1.0	TX 20
M 5	1.6	8.94	9.3	2.70	1.3	TX 25
M 6	2.0	10.87	11.3	3.30	1.5	TX 30

Nominal dimension	Length (l)	
	min.	max.
6	5.62	6.38
8	7.55	8.45
10	9.55	10.45
12	11.45	12.55

Nominal dimension	Length (l)	
	min.	max.
16	15.45	16.55
20	19.35	20.65
25	24.35	25.65
30	29.35	30.65



B 7500 PE
Button head, hexalobular drive
zinc-plated

Diameter (mm) \ Length (mm)	2.5	3.0	4.0	5.0	6.0
5	B7500PEV12,55	B7500PEV135			
6	B7500PEV12,56	B7500PEV136	B7500PEV146		
8	B7500PEV12,58	B7500PEV138	B7500PEV148	B7500PEV158	
10	B7500PEV12,510	B7500PEV1310	B7500PEV1410	B7500PEV1510	B7500PEV1610
12		B7500PEV1312	B7500PEV1412	B7500PEV1512	B7500PEV1612
14			B7500PEV1414		
16		B7500PEV1316	B7500PEV1416	B7500PEV1516	B7500PEV1616
20			B7500PEV1420	B7500PEV1520	B7500PEV1620
25				B7500PEV1525	B7500PEV1625
30				B7500PEV1530	B7500PEV1630

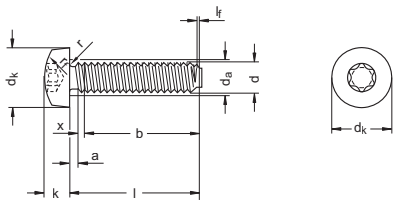

rf = Furchbereich

Diameter (d)	a max.	b min.	da max.	min. dk	max. dk	min. k	max. k	rf	r min.	Pitch (P)	x max.	Tool size
M 2.5	0.9	25	3.1	4.70	5.0	1.96	2.1	4.0	0.10	0.45	1.10	TX 8
M 3	1.0	25	3.6	5.30	5.6	2.26	2.4	5.0	0.10	0.50	1.25	TX 10
M 4	1.4	38	4.7	7.64	8.0	2.92	3.1	6.5	0.20	0.70	1.75	TX 20
M 5	1.6	38	5.7	9.14	9.5	3.52	3.7	8.0	0.20	0.80	2.00	TX 25
M 6	2.0	38	6.8	11.57	12.0	4.30	4.6	10.0	0.25	1.00	2.50	TX 30

Nominal dimension	Length (l)	
	min.	max.
5	4.62	5.38
6	5.62	6.38
8	7.62	8.38
10	9.55	10.45
12	11.55	12.45

Nominal dimension	Length (l)	
	min.	max.
14	13.45	14.55
16	15.45	16.55
20	19.45	20.55
25	24.45	25.55
30	29.45	30.55



EJOT ALtracs® Plus – the “Specialist” for light metals

EJOT ALtracs® Plus screws are specially developed self-tapping fasteners to achieve maximum strength for screw connections in light metal materials and other non-ferrous metals such as zinc, copper, and brass up to a hardness of 140 HB. The ALtracs® Plus screw can be screwed directly into the cast hole. Compared to metric screws, they can lead to significant cost savings, since they reduce the number of processes (e.g. thread cutting).

As the further development of the ALtracs® screw, the ALtracs® Plus achieves strength values similar to a strength class 10.9 metric screw.

Optimized thread design

The thread geometry is especially important for self-tapping fastening in light metals, as the difference in the material strengths of steel versus light metal requires the steel screw to be specifically calibrated. The 33° screw flank angle forms a female thread with significantly higher strength than that of 60° threads. The female thread of the weaker light metal material is strengthened by the thicker thread ridge that is formed, achieving a balanced stability ratio. The asymmetry of the flank angle provides optimal material displacement and high surface coverage.

Safe assembly

The resulting low insertion torques and high overtorques of the ALtracs® Plus screws create a large range for safe assembly with simple pneumatic and electric screwing devices. In addition, torque- and angle-controlled tightening methods can be implemented in the overelastic range of the screw, since overtightening or screw brake can be defined as failure criteria in the design. Thus the circular thread cross-section, in combination with different screw-in depths (1 to 2.5 × d), allows a high degree of flexibility in selecting the appropriate screw connection system. The thread flanks of the ALtracs® Plus, which have a pointed shape all the way forward, in connection with the tapered groove tip, allow the screw to be centered and screwed in easily, even in cast holes, with hand-held screw assembly tools.

Advantages / Features

- 33° flank angle
- Circular cross section
- Metric compatibility
- Tapered groove tip
- Preload force and setting characteristics comparable to metric 10.9 screws
- Thread geometry allows castable bore tolerances

Available materials

- Heat-treated steel analogous to strength class 10.9
- A2/A4 stainless steel



Standard product range

EJOT ALtracs® Plus E 5151
Button head with pressed-on washer, TORX®
zinc-plated

Diameter (mm) \ Length (mm)	3.0		4.0	
	8			
10	E5151K/VZ3010			E5151VZ4010
12	E5151K/VZ3012			E5151VZ4012
14	E5151K/VZ3014			E5151VZ4014
16	E5151K/VZ3016			E5151VZ4016
18	E5151K/VZ3018			E5151VZ4016
20				E5151VZ4020

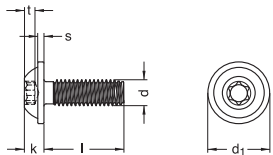

Diameter (d)	d ₁ Nominal dimension	k Nominal dimension	s Nominal dimension	Pitch (P)	t min.	Tool size
3	7.5	2.3	0.7	0.50	1.0	TX 10
4	10	2.9	1.0	0.70	1.3	TX 20
5	12	3.4	1.2	–	1.5	TX 25

Nominal dimension	Length (l)		Nominal dimension	Length (l)	
	min.	max.		min.	max.
8	7.71	8.29	14	13.65	14.35
10	9.71	10.29	16	15.65	16.35
12	11.65	12.35	20	19.58	20.42

The EJOT ALtracs® Plus is also available in variants with a button head and countersunk head.

ECONomic TECHNical Engineering: Application technology

Faster, better, lower costs: the optimal connection technology for your products.

Connection technology on the test bench

Different joining processes, material types, surface treatments, and dimensions often lead to a wide range of products in the C-parts sector. The result is high procurement costs, as well as time-consuming and cost-intensive internal processes. Our application engineers work closely with you to develop solutions to reduce your costs by optimizing products and processes.

In order to fully exploit the existing saving potential, you should contact us at the earliest possible stage in product development. But even in existing applications, small optimizations can have enormous effects. As a service provider with our own production and development, we have the necessary experience in applications and manufacturing that allows us to recommend the most economically viable connection technology.

Automation-capability and maximum process reliability are further important prerequisites for efficient assembly. Our consulting services also focus on service-oriented handling and reducing tool costs. Often, a large variety of different elements complicates assembly and preparation in production. We provide you with targeted advice on possible product range optimization – always taking your specific requirements into account.

Calculations

For calculations on screw connection, all the important parameters, such as material values, coefficients of friction, various forces, and geometric data, need to be taken into account. Different calculation standards have become established in different domains of application (VDI Guideline 2230, Eurocode 3, DIN 25201, etc.). We can offer you a wide range of support in this area too, including the use of modern IT systems.



Prototyping

As a specialist in self-tapping fastening, we support our customers along the entire value chain, drawing on a variety of tools. As part of our collaboration with customers, we are happy to offer them state-of-the-art rapid prototyping processes. We support you with initial ideas and concepts for your design, from the very beginning of your projects and as they progress. Thanks to close cooperation between our application engineers, laboratory specialists, as well as our production and prototyping staff, we are able to implement product proposals and applications quickly and analyze their technical and commercial characteristics.

Screw-in tests

Once initial ideas have been validated, they can be subjected to practical tests quickly. The design for connections with self-tapping fasteners in plastic parts is explained in guidelines including DVS 2241-1. The method described there is based on relevant empirical values combined with practical tests on the components to be screwed or corresponding samples. In this domain as well, additive manufacturing processes offer completely new possibilities, which we would be happy to present to you. For other materials, it is possible to draw on relevant standards, such as DIN EN ISO 7085 for steel. Screw connection tests are also strongly recommended in this case. Our accredited in-house laboratory with extensive testing facilities is available for this purpose. Furthermore, our application engineers are also available for mobile on-site deployment with test benches to investigate all the important parameters of your screw connections.

Training and on-site inspections

We are also available on site to answer any questions you may have about connection technology. This can take the form of a personal visit we call "tech day" or be done on an individual basis during a visit to view your assembly process. Our application engineers analyze production processes on site and work with you to optimize them.

Would you like a consultation? Contact us!



BÖLLHOFF



Böllhoff Group

Innovative partner for joining technology with assembly and logistics solutions.

Find your local partner at www.boellhoff.com or contact us at message@boellhoff.com.

Passion for successful joining.